



Revision: 1.5 - 07/09/2012

LA-7500-00

Sportster 1" Rear Lowering Kit Instructions For 1989-2004 HD XL Models

Page: 1

Empty rectangular box

INCLUDED IN THE KIT:

(2) 1/2-13 x 2.5" Hex Head Gold Zinc	(4) 1/2-13 Thin Nylock Nut Clear Zinc
(2) 1/2-13 x 1.5" Hex Head Gold Zinc	(4) 1/2" Flat Washer

INSTRUCTIONS:

1.) With a motorcycle jack or floor jack, lift enough weight off of the wheels so that the existing shock bolts can be removed with ease. Remove the lower shock bolts and axle adjuster hardware. Consult your service manual for proper procedures pertaining to your specific bike.

2.) Loosen the bolt at the top of the shock and move the shock towards the back of the bike and tighten the bolt on the top of the shock just enough to keep it out of the way.

3.) Repeat on the other side.

Note: We recommend applying Loctite to all fasteners during installation.

4.) Starting with the right side bracket, install the lowering block over the shock mount on the swing arm. Secure in place with supplied 1/2-13 x 1 1/2" long hex bolt, washer and nylock nut. Do not tighten the bolts all the way. Repeat with left side bracket.

5.) Loosen the bolt at the top of the shock. Lower the shock and align the mount hole of the shock to the holes on the lowering blocks. Secure shock to lowering block with supplied 1/2 -13 x 2 1/2" long hex bolt, washer and nylock nut. Do not tighten the bolts all the way.

6.) Repeat on other side. Tighten all bolts to torque specs from your service manual for the stock shock. Reinstall the axle adjuster hardware per your service manual.

7.) Lower bike from jack, check that all nuts and bolts are secure.

WARNING: Installing a lowering kit will decrease initial ground clearance. The motorcycle will be lower to the ground and care should be taken to avoid bottoming, especially over bumps or in turns. To maintain proper balanced geometry, the front and rear of the motorcycle should be lowered equally. Failure to properly install the lowering kit and operate the motorcycle after installation may result in serious injury or death to the rider.

LIMITED GUARANTY: Because we cannot control the application of our products, buyer assumes risks for any and all damage caused to him or herself or any third party by virtue of any failure of these parts. Guaranty for such parts is limited to our replacement costs thereof. This guaranty is in lieu of all other guaranties or warranties express or implied, and all other such guaranties or warranties are hereby expressly disclaimed. By installation of these parts, buyer irrevocably agrees to the foregoing.

Our install guides provide a basic outline on the proper installation of our products. Further tuning and/or fitment may be required. LA Choppers bears no responsibility on installation costs associated with this product.
© 2020 LA Choppers



New Shock Mount

OEM Shock Mount

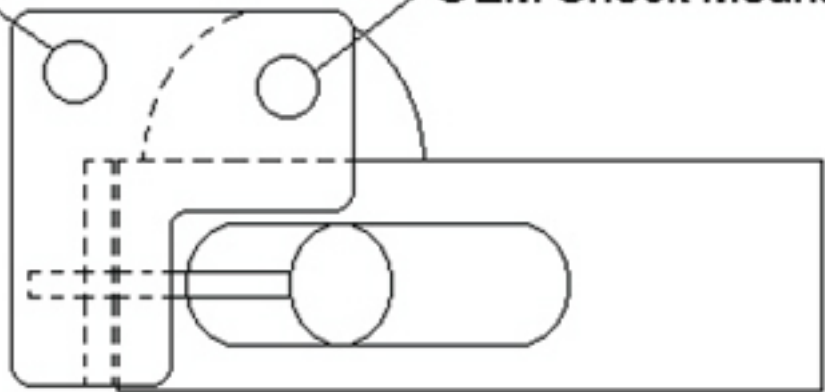

Right Side View

Our install guides provide a basic outline on the proper installation of our products. Further tuning and/or fitment may be required. LA Choppers bears no responsibility on installation costs associated with this product.
© 2020 LA Choppers